



Educational
Insights®

EI-3664

Ages **3+**

PlayBrix™ Royal Adventure



Build on your imagination! These bricks and accessories will take your creative construction play to the next level.

Includes:

- 8 Large rectangle bricks (12" x 6" x 3")
- 10 Small rectangle bricks (6" x 6" x 3")
- 20 Square bricks (6" x 3" x 3")
- 4 Pyramid bricks (6" x 5" x 5")
- 4 Triangle bricks (6" x 5" x 3")
- 7 Accessories

Ladrillos para construir aventuras principescas

¡Construye lo que imaginas! Con estos ladrillos y accesorios podrás llevar tus juegos de construcción creativa a un nivel superior.

Incluye:

- 8 ladrillos rectangulares grandes (30 cm x 15cm x 7,5cm)
- 10 ladrillos rectangulares pequeños (15cm x 15cm x 7,5cm)
- 20 ladrillos cuadrados (15cm x 7,5cm x 7,5cm)
- 4 ladrillos piramidales (15cm x 12cm x 12cm)
- 4 ladrillos triangulares (15cm x 12cm x 7,5cm)
- 7 accesorios

Cubes de construction Aventure royale

Laissez libre cours à votre imagination ! Ces cubes et accessoires vont faire passer votre jeu de construction créatif à la vitesse supérieure.

Comprend :

- 8 grands rectangles (30 cm x 15 cm x 7,5 cm)
- 10 petits rectangles (15 cm x 15 cm x 7,5 cm)
- 20 cubes (15 cm x 7,5 cm x 7,5 cm)
- 4 pyramides (15 cm x 12 cm x 12 cm)
- 4 triangles (15 cm x 12 cm x 7,5 cm)
- 7 accessoires

Abenteuer-Bausteine „Königsschloss“

Baue deine Phantasie auf! Die Spiel-Ziegelsteine samt Zubehör nehmen dich mit auf die kreative Reise – gestalte Bauwerke wie ein Profi.

Enthält:

- 8 große rechteckige Ziegelsteine (30 x 15 x 7,5 cm)
- 10 kleine rechteckige Ziegelsteine (15 x 15 x 7,5 cm)
- 20 quadratische Ziegelsteine (15 x 7,5 x 7,5 cm)
- 4 pyramidenförmige Ziegelsteine (15 x 12 x 12 cm)
- 4 dreieckige Ziegelsteine (15 x 12 x 7,5 cm)
- 7 Zubehörteile



Assembly Instructions

Instrucciones de montaje • Instructions de montage • Montageanweisungen

FOR THE SQUARE AND THE RECTANGULAR BRICKS:

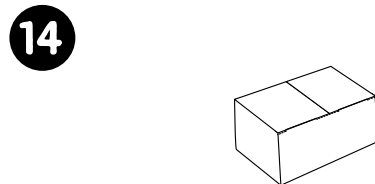
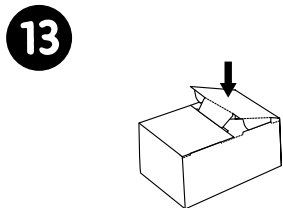
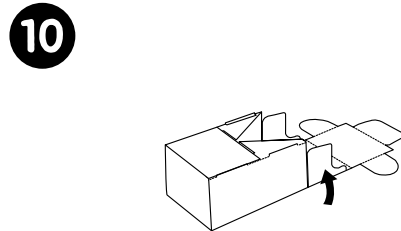
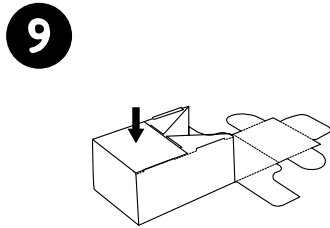
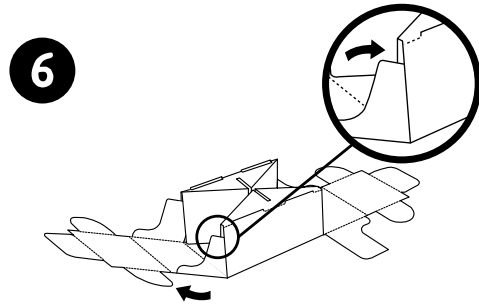
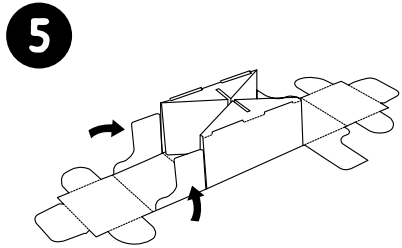
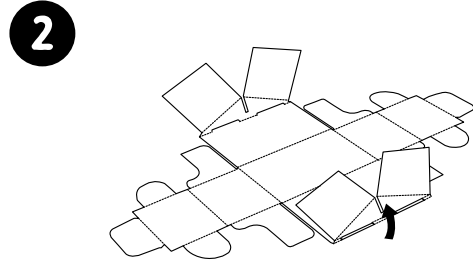
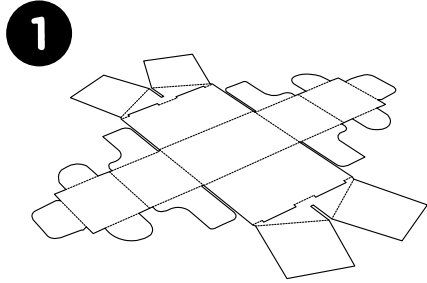

PARA LOS LADRILLOS CUADRADOS Y RECTANGULARES:

POUR LES CUBES ET LES RECTANGLES :

RECHTECKIGE UND QUADRATISCHE ZIEGELSTEINE:

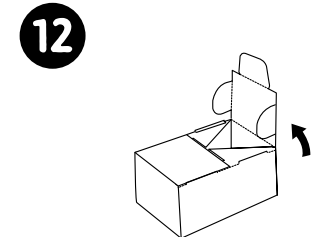
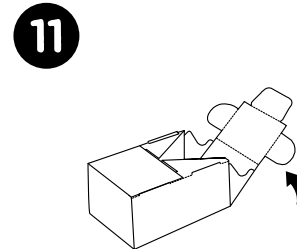
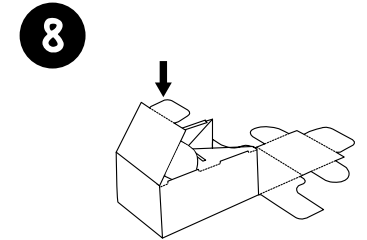
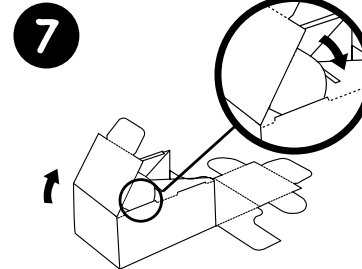
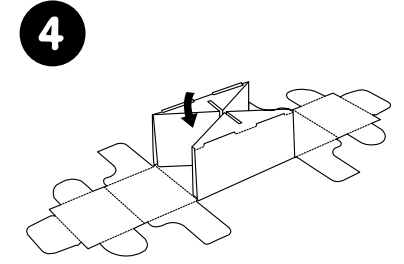
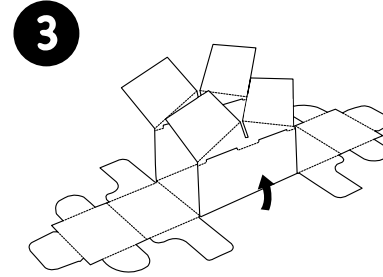

FOR THE PYRAMID:
PARA LA PIRÁMIDE:
POUR LES PYRAMIDES :
PYRAMIDE:

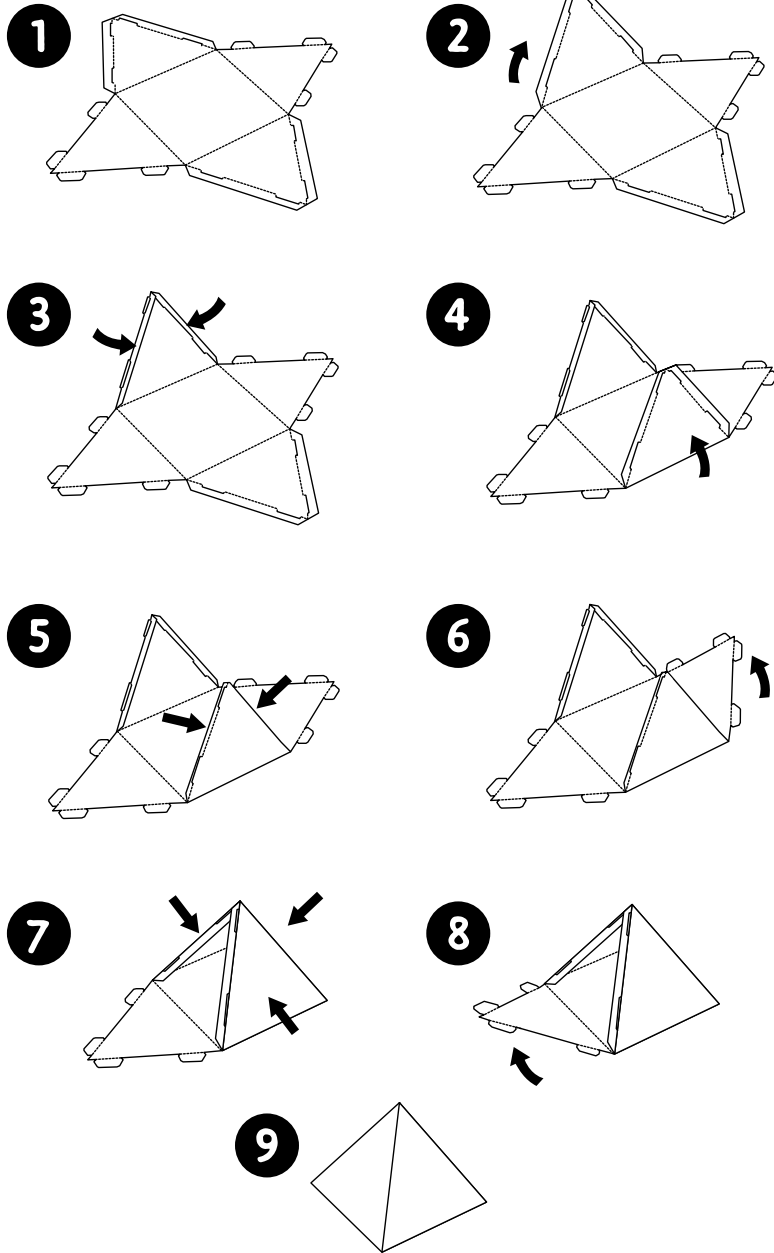

FOR THE TRIANGLE:
PARA EL TRIÁNGULO:
POUR LES TRIANGLES :
DREIECK:

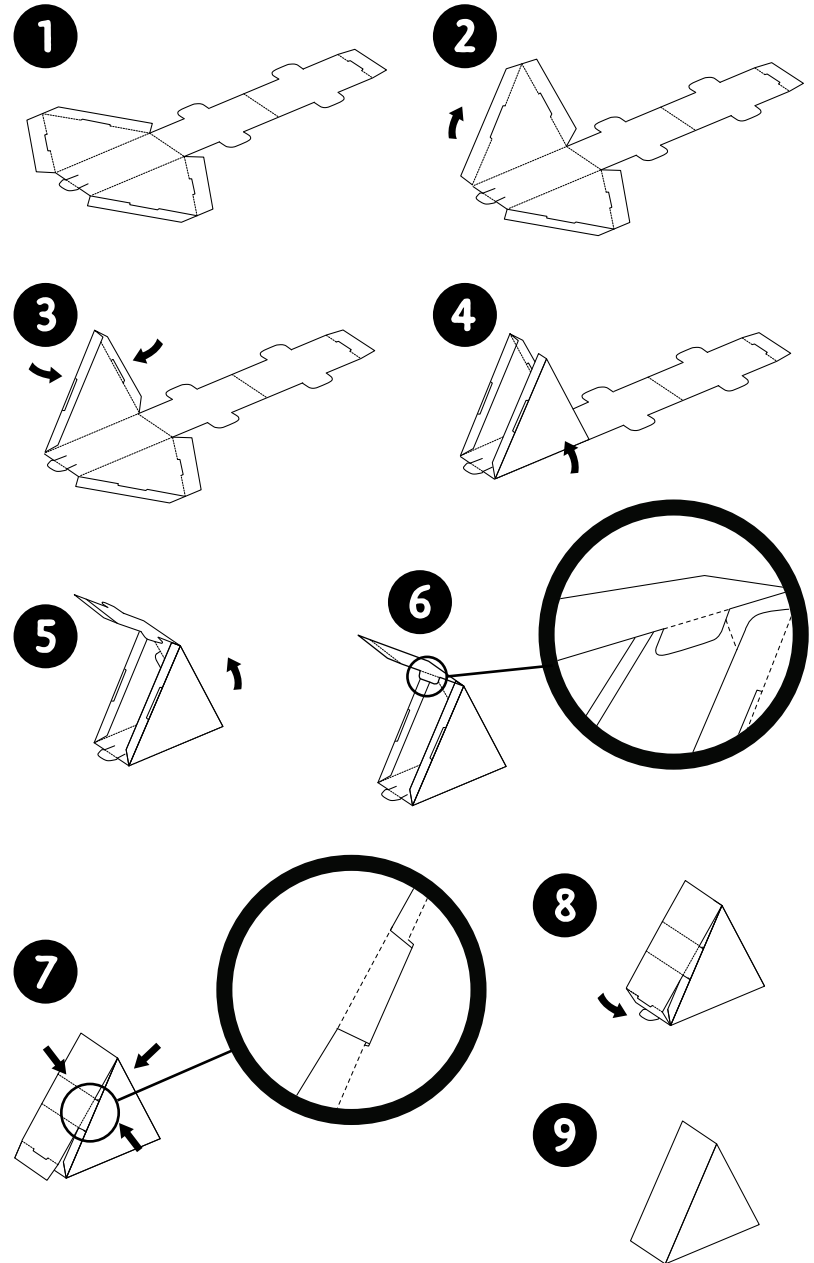

Using the Accessories

Uso de los accesorios • Utilisation des accessoires
• Verwendung des Zubehörs



Some accessories are designed to be inserted into slots/seams of the bricks.

Algunos accesorios están diseñados para encajarse en las ranuras/uniones de los ladrillos.

Certains accessoires sont conçus pour être insérés dans des encoches des éléments de construction.

Einige Zubehörteile kannst du in die Schlitz-/Falze der Ziegelsteine stecken.



Some accessories are designed to be worn (some assembly required).

Algunos accesorios están diseñados para llevarlos puestos (requieren montaje).

Certains accessoires sont conçus pour être portés sur soi (assemblage requis).

Einige Zubehörteile kannst du am Körper tragen (geringe Montage erforderlich).



Some accessories are designed to be hung on ledges created by your bricks.

Algunos de los accesorios están diseñados para colgarse de las cornisas de las murallas que construyas con los ladrillos.

Certains accessoires sont conçus pour être accrochés sur les bords créés par les cubes.

Einige Zubehörteile kannst du an den Ziegelsteinen an die entstandenen Vorsprünge hängen.

Developed in Southern California by Educational Insights.
© Educational Insights, Gardena, CA (U.S.A.). All rights reserved.
Learning Resources Ltd., Bergen Way, King's Lynn, Norfolk, PE30 2JG, UK.
Please retain the package for future reference. Made in China.
educationalinsights.com

Hecho en China. Conserva el envase para futuras consultas.
Fabriqué en Chine. Veuillez conserver l'emballage.
Hergestellt in China. Bitte Verpackung gut aufbewahren.

Tell us what you **THINK!**
REVIEW this product at
educationalinsights.com

